

Installation Manual

5647000M

Omnivore® 2 hp Grinder Pumps

LSG and LSGX-Series

Models

LSG200-Series

Single-Stage

LSGX200-Series

2-Stage High Head



For pressure sewer applications, verify a Redundant Check Valve Assembly (curb stop and check valve) is installed between the pump discharge and the street main, as close to the public right-of-way as possible, on all installations to protect from system pressures.



NOTICE

Installer: Manual must remain with owner/operator.

Prior to installation, record information from pump nameplate for future reference:

7000 Apple Tree Avenue
Bergen, NY 14416
ph: 1-800-543-2550
fax: 1-585-494-1839
www.LibertyPumps.com

Keep this manual handy for future reference.
For replacement manual, visit LibertyPumps.com,
or contact Liberty Pumps at 1-800-543-2550.
Retain dated sales receipt for warranty.

Model: _____

Serial: _____









Mfg Date: _____

Install Date: _____

Contents

Safety Precautions	2 EN
General Information	4 EN
Operating Constraints	4 EN
Model Specifications	4 EN
Inspection and Storage	4 EN
Pump Design	4 EN
Pump System Components	5 EN
Wiring Instructions	6 EN
Preparation	6 EN
Installation	7 EN
Operation	8 EN
Maintenance and Troubleshooting	9 EN
Warranty	12 EN

Safety Guidelines

	This safety alert symbol is used in the manual and on the pump to alert of potential risk for serious injury or death.
	This safety alert symbol identifies risk of electric shock . It is accompanied with an instruction intended to minimize potential risk of electric shock.
	This safety alert symbol identifies risk of fire . It is accompanied with an instruction intended to minimize potential risk of fire.
	This safety alert symbol identifies risk of serious injury or death . It is accompanied with an instruction intended to minimize potential risk of injury or death.
	Warns of hazards which, if not avoided, will result in serious injury or death.
	Warns of hazards which, if not avoided, could result in serious injury or death.
	Warns of hazards which, if not avoided, could result in minor or moderate injury.
	Signals an important instruction related to the pump. Failure to follow these instructions could result in pump failure or property damage.

	Read every supplied manual before using pump system. Follow all the safety instructions in manual(s) and on the pump. Failure to do so could result in serious injury or death.
---	---

Safety Precautions

RISK OF ELECTRIC SHOCK

- Accidental contact with electrically live parts, items, fluid, or water can cause serious injury or death.
- Always disconnect pump(s) from power source(s) before handling or making any adjustments to either the pump(s), the pump system, or the control panel.
- All installation and maintenance of pumps, controls, protection devices, and general wiring shall be done by qualified personnel.
- All electrical and safety practices shall be in accordance with the National Electrical Code®, the Occupational Safety and Health Administration, or applicable local codes and ordinances.
- Do not remove cord and strain relief, and do not connect conduit to pump.
- Pump shall be properly grounded using its supplied grounding conductor. Do not bypass grounding wires or remove ground prong from attachment plugs. Failure to properly ground the pump system can cause all metal portions of the pump and its surroundings to become energized.
- Do not handle or unplug the pump with wet hands, when standing on damp surface, or in water unless wearing Personal Protective Equipment.
- Always wear dielectric rubber boots and other applicable Personal Protective Equipment (PPE) when water is on the floor and an energized pump system must be serviced, as submerged electrical connections can energize the water. Do not enter the water if the water level is higher than the PPE protection or if the PPE is not watertight.
- Do not lift or carry a pump or a float assembly by its power cord. This will damage the power cord, and could expose the electrically live wires inside the power cord.
- The electrical power supply shall be located within the length limitations of the pump power cord, and for below grade installations it shall be at least 4 ft (1.22 m) above floor level.
- Do not use this product in applications where human contact with the pumped fluid is common (such as swimming pools, fountains, marine areas, etc.).
- Protect the power and control cords from the environment. Unprotected power and control (switch) cords can allow water to wick through ends into pump or switch housings, causing surroundings to become energized.
- Single-phase 208/230V pumps shall only be operated without the float switch by using the circuit breaker or panel disconnect.
- Some products may have internal capacitors that could cause shock. Avoid contact with plug ends after removing from energy source.

⚠️ WARNING**RISK OF FIRE**

- Do not use an extension cord to power the product. Extension cords can overload both the product and extension cord supply wires. Overloaded wires will get very hot and can catch on fire.
- This product requires a separate, properly fused and grounded branch circuit, sized for the voltage and amperage requirements of the pump, as noted on the nameplate. Overloaded branch circuit wires will get very hot and can catch on fire. When used, electrical outlets shall be simplex of the appropriate rating.
- For cord replacement: power cord must be of the same length and type as originally installed on the Liberty Pumps product. Use of incorrect cord may lead to exceeding the electrical rating of the cord and could result in death, serious injury, or other significant failure.
- Do not use this product with or near flammable or explosive fluids such as gasoline, fuel oil, kerosene, etc. If rotating elements inside pump strike any foreign object, sparks may occur. Sparks could ignite flammable liquids.
- Sewage and effluent systems produce and may contain flammable and explosive gases. Prevent introduction of foreign objects into basin as sparks could ignite these gases. Exercise caution using tools and do not use electronic devices or have live, exposed electrical circuits in or around basins, open covers and vents.
- These pumps are not to be installed in locations classified as hazardous in accordance with the National Electric Code[®], ANSI/NFPA 70.

⚠️ WARNING**RISK OF SERIOUS INJURY OR DEATH**

- Energizing the control panel or breaker for the first time is potentially dangerous. Licensed electrical personnel should be present when the panel or breaker is energized for the first time. If faults caused by damage or poor installation practices have not been detected, serious damage, injury or death can result when power is applied.
- Do not modify the pump/pump system in any way. Modifications may affect seals, change the electrical loading of the pump, or damage the pump and its components.
- All pump/pump system installations shall be in compliance with all applicable Federal, State, and Local codes and ordinances.
- Do not allow children to play with the pump system.
- Do not allow any person who is unqualified to have contact with this pump system. Any person who is unaware of the dangers of this pump system, or has not read this manual, can easily be injured by the pump system.
- In 208/230V installations, one side of the line going to the pump is always "hot", whether the float switch is on or off. To avoid hazards, install a double pole disconnect near the pump installation.
- Vent basin in accordance with local code. Proper venting of sewer and effluent gases alleviates poisonous gas buildup and reduces the risk of explosion and fire from these flammable gases.

- Wear adequate Personal Protective Equipment when working on pumps or piping that have been exposed to wastewater. Sump and sewage pumps often handle materials that can transmit illness or disease upon contact with skin and other tissues.
- Do not enter a pump basin after it has been used. Sewage and effluent can emit several gases that are poisonous.
- Do not remove any tags or labels from the pump or its cord.
- Keep clear of suction and discharge openings. To prevent injury, never insert fingers into pump while it is connected to a power source.
- Do not use this product with flammable, explosive, or corrosive fluids. Do not use in a flammable and/or explosive atmosphere as serious injury or death could result.
- This product contains chemicals known to the State of California to cause cancer and birth defects or other reproductive harm. www.p65warnings.ca.gov.
- A grinder pump contains metal parts that rotate at high speeds. Be careful around pump base while power is connected. Make sure that the pump is either in the tank or clear from people and wires when in operation.
- Wear Personal Protective Equipment to protect hands as cutter blades have extremely sharp edges and present a serious cutting hazard.

⚠️ CAUTION

- ◆ This pump has been evaluated for use with water only, however use with human waste and toilet paper is permitted.

NOTICE

- ◆ For pressure sewer applications, verify a Redundant Check Valve Assembly (curb stop and check valve) is installed between the pump discharge and the street main, as close to the public right-of-way as possible, on all installations to protect from system pressures.
- ◆ Check 3-phase pumps for correct rotation prior to installing pump(s) in basin. To change rotation, reverse any two of the three power leads to the pump (not the ground). Code the wires for reconnection after installation.
- ◆ Do not dispose of materials such as paint thinner or other chemicals down drains. Doing so could chemically attack and damage pump system components and cause product malfunction or failure.
- ◆ Do not use pumps with fluid over 140°F (60°C). Operating the pump in fluid above this temperature can overheat the pump, resulting in pump failure. Maximum continuous duty fluid temperature is 104°F (40°C).
- ◆ Do not use pump system with mud, sand, cement, hydrocarbons, grease, or chemicals. Pump and system components can be damaged from these items causing product malfunction or failure. Additionally, flooding can occur if these items jam the impeller or piping.
- ◆ The Uniform Plumbing Code[®] states that sewage systems shall have an audio and visual alarm that signals a malfunction of the system, to reduce the potential for property damage.
- ◆ Do not position the pump float directly under the inlet from drain tile or in the direct path of any incoming water.

- ◆ Submersible Pump—do not run dry
- ◆ Keep pump upright.
- ◆ At no time should the pump be stored within an incomplete wet pit. The pump should not be placed into the pit until it can be fully operational.
- ◆ Do not allow the pump to freeze.

General Information

Before installation, read these instructions carefully. Each pump is individually factory tested to ensure proper performance. Closely following these instructions will eliminate potential operating problems, assuring years of trouble-free service.

The LSG/LSGX-Series pumps are to be used for handling septic tank effluent, sewage, and drain (storm) water.

Provide pump serial number in all correspondence.

Pumps are CSA certified to CSA and UL® standards.

Pumps must be serviced at a qualified repair facility approved by Liberty Pumps. No repair work should be carried out during the warranty period without prior factory approval. Any unauthorized field repairs void warranty. Contact Liberty Pumps at 1-800-543-2550 to locate the closest authorized service center.

Operating Constraints

It is extremely important to verify that the pump has been sized correctly for the intended installation. The operating point of the pump must lie within the acceptable range as outlined by the applicable Liberty Pumps performance chart. Operating the pump outside of the recommended range can invalidate the CSA Certification of the pump and can also cause damage and premature failure. Operating outside of the recommended range can cause the pump to exceed its rated nameplate amp draw, which will void the pump certification. It can also cause motor overheating, cavitation, excessive vibration, clogging, and poor energy efficiency.

Model Specifications

For complete listing of models and their specifications, refer to <http://www.LibertyPumps.com/About/Engineering-Specs>. Pump nameplate provides a record of specific pump information.

Inspection and Storage

Initial Inspection

The pump should be immediately inspected for damage that may have occurred in shipment.

1. Visually check the pump and any spare parts for damage.

2. Check for damaged electrical wires, especially where they exit the motor housing.

Contact Liberty Pumps customer service to report any damage or shortage of parts.

Storage Before Use

⚠ WARNING **RISK OF ELECTRIC SHOCK**

- Protect the power and control cords from the environment. Unprotected power and control (switch) cords can allow water to wick through ends into pump or switch housings, causing surroundings to become energized.

NOTICE

- ◆ At no time shall the pump be stored within an incomplete wet pit. The pump shall not be placed into the pit until it can be fully operational.
- ◆ Do not allow the pump to freeze.

LSG/LSGX-Series Omnivore grinder pumps are shipped from the factory ready for installation and use. The pump should be held in storage if the pump station is not complete.

If storage is necessary, the pump should remain in its shipping container. It should be stored in a warehouse or storage shed that has a clean, dry temperature-stable environment where the pump and its container are covered to protect it from water, dirt, vibration, etc. The cord ends must be protected against moisture.

Uninstalled pumps that are idle for greater than three months should have cutters and impellers manually rotated once a month to lubricate the seals.

Installed pumps that are idle for greater than one month should have impellers and cutters manually operated through the breaker panel once a month to lubricate the seals. **For automatic models**, turn off the breaker, unplug the piggyback switch, and plug the pump directly into receptacle. Turn the breaker on for 30 seconds, then turn the breaker off. Plug the piggyback switch back in. Refer to **Piggyback Switch Operation**.

Pumps that are idle in a wet basin must be removed.

Pump Design

LSG/LSGX-Series grinder pumps are designed for continuous underwater operation. The motor and pump form a close coupled, watertight unit. The induction motor is insulated against heat and moisture in accordance with Class B 265°F (130°C) regulations.

A thermal overload protector is embedded in the stator windings. This is connected in series and wired to shut down the pump if overheating occurs. The overload switch resets automatically when the motor cools.

The motor is protected against damage from water entry by two seals. The lower seal is a Viton lip seal and the upper seal is a graphite impregnated silicon carbide hard face seal.

The impeller and volute are designed for efficient flow characteristics and clog-free operation. The hardened cutters grind solids and fibrous matter into small particles that can be safely pumped through small diameter piping.

Pump System Components

Control Panel

Manual LSG/LSGX-Series pumps require a separate, approved pump control panel for automatic operation. Operation of these models will be according to the control selected. Refer to separate manufacturer's instructions supplied with the unit. Verify the electrical specifications for the control panel properly match those of the pump.

Mounting, installation, and wiring connections are specific to the control panel used. Refer to the manufacturer's instructions supplied with the unit.

IMPORTANT: When connecting an LSG/LSGX-Series pump to an existing control panel, verify the panel is correctly sized and equipped for the pump.

Control panels designed for use with the LSG/LSGX-Series pumps available from Liberty Pumps can be found at http://www.LibertyPumps.com/Portals/0/Files/panel_selection_guide.pdf or contact Liberty Pumps.

LSG202M-C and LSGX202M-C models require a panel-mounted start circuit consisting of a start capacitor, run capacitor, and start relay, which are available separately. Refer to Table 1 for these control panel components.

Table 1. Control Panel Components 1-Phase

Required Component and Specification	Liberty Pumps P/N
208V 1-phase Start Kit (contains 3 items listed separately below)	K001316
Start Capacitor, 200–240 μ F 220 VAC	
Run Capacitor, 50 μ F 370 VAC	
Start Relay, Mars Potential Relay 19551 #551	

Overload Protection

Three-phase LSG/LSGX-Series grinder pumps require overload protection in the control panel. The motor control unit shall be approved and shall be properly sized or adjusted for the full load input power indicated on the pump nameplate. It is important to properly adjust or select the motor control overload protection. The full load amperes on the nameplate should be used as a baseline, but it is important to consider that events such as supply voltage variation or large solids passing through the pump can temporarily increase current draw. To avoid possible nuisance tripping, it may be necessary to adjust overloads to a value slightly higher than the full load input power indicated on the pump nameplate.

Thermostat

Single-phase pump models are protected from locked rotor and running overloads by a thermal overload (thermostat) integrally mounted to the motor and wired to shut down the pump if overheating occurs. The thermostat resets automatically after the pump has cooled.

Power and Control Cords

⚠ WARNING **RISK OF ELECTRIC SHOCK**

- Do not remove cord and strain relief, and do not connect conduit to pump.

The power and control cords cannot be spliced; a junction box may be used.

IMPORTANT: Each cord has a green lead. This is the ground wire and must be grounded properly per NEC[®] and/or local codes.

Float Switches

Pump ON and OFF cycles are controlled by float switches in the wet well (basin). Automatic pumps have a "piggyback" float switch attached to the side of the pump, while manual pumps have float switches attached to the control panel. Refer to control panel or switch instructions for proper electrical connection.

Float Sequence: Piggyback (Automatic Models)

- As the liquid level in the basin rises, the float tilts, closing the switch. This starts the pump.
- The pump runs until the liquid level falls below the pump OFF level of the float (factory set at 7 in), emptying the basin.

Float Sequence: Simplex (Manual Models)

- As the liquid level in the basin rises, the pump OFF float tilts, closing the switch. This level must be set at a minimum of 7 in. As the liquid level continues to rise, the pump ON float tilts. This switch closes, starting the pump.
- The pump runs until the liquid level falls below the pump OFF float, emptying the basin.
- In the event of a malfunctioning float switch, control relay, or pump, the liquid level rises and tilts the HIGH LEVEL ALARM float. The alarm system will activate.

Float Sequence: Duplex (Manual Models)

- As the liquid level in the basin rises, the pump OFF float tilts, closing the switch. As the liquid level continues to rise, the lead pump ON float tilts. This switch closes, starting the lead pump.
- The pump runs until the liquid level falls below the pump OFF float, emptying the basin.
- On the next rise of the liquid level, the other pump will start on the lead pump ON signal. The pumps will continue to alternate their cycles.
Note: The ON/OFF float switch differential should be set as to not exceed 12 starts per hour.
- If the liquid level rises to the lag pump ON float, the second pump will start. Both pumps will run until the liquid falls below the pump OFF float, emptying the basin.
- In the event of a malfunctioning float switch, control relay, or pump, the liquid level rises and tilts the HIGH LEVEL ALARM float. The alarm system will activate.

Wiring Instructions

⚠️ RISK OF ELECTRIC SHOCK

- Always disconnect pump(s) from power source(s) before handling or making any adjustments to either the pump(s), the pump system, or the control panel.
- All installation and maintenance of pumps, controls, protection devices, and general wiring shall be done by qualified personnel.
- All electrical and safety practices shall be in accordance with the National Electrical Code®, the Occupational Safety and Health Administration, or applicable local codes and ordinances.

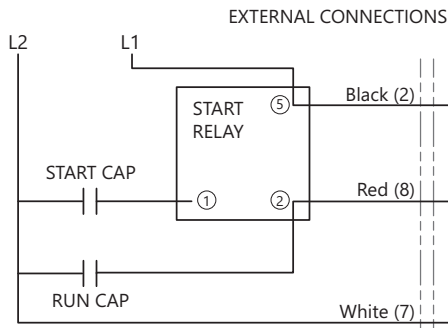

Figure 1. Wiring Diagram 1-Phase, External Capacitor

208V/230V 3PH	440-480V 3PH	575V 3PH
L1 → black red	L1 → black brown ↔ red	L1 → black
L2 → pink white	L2 → pink orange ↔ white	L2 → pink
L3 → violet blue	L3 → violet yellow ↔ blue	L3 → violet

Figure 2. Wiring Connections 3-Phase

Preparation

⚠️ RISK OF ELECTRIC SHOCK

- Always disconnect pump(s) from power source(s) before handling or making any adjustments to either the pump(s), the pump system, or the control panel.

Prepare Basin

The basin required for effluent and sewage applications must be sealed and vented to meet health and plumbing code requirements. If replacing a previously installed pump, prepare the basin by removing the old pump and cleaning any debris from the basin. Inspect all remaining equipment in the basin including guide rails, piping, valves, and electrical junction boxes (if present) and repair or replace as appropriate. Ensure that control hardware such as floats or pressure transducers are clean, properly adjusted, and in good working order.

Pump installation should be at a sufficient depth to ensure that all plumbing is below the frost line. If this is not feasible, remove the check valve and size the basin and/or adjust pump differential to accommodate the additional backflow volume. Consult Liberty Pumps for details on how this should be done.

Pump Control and Alarm Floats

The engineering drawings will generally specify the levels for Pump ON, Pump OFF, and HIGH LEVEL ALARM. If they are not specified, the guidelines in Table 2 should be used to determine float switch locations. The upper water level should be positioned to minimize pump starts. The HIGH LEVEL ALARM float must be above the Pump ON float but below any inlets. No float should be set above the inlet to the basin.

Table 2. Float Switch Installation Guidelines

	Float	Levels
Piggyback Switch (1-Float System)	OFF	Factory set at float tether 4".
	ON	
Simplex Pump Station (3-Float System)	OFF	Level to top of motor housing.
	ON	
	HIGH LEVEL ALARM	Minimum 1' above pump ON level and below inlet pipe.
Duplex Pump Station (4-Float System)	OFF	
	Lead Pump ON	Minimum 1-1/2' above pump OFF level.
	Lag Pump ON	
	HIGH LEVEL ALARM	Minimum 1' above lag pump ON level and below inlet pipe.

Cutter and Impeller Free Movement Check

⚠️ RISK OF SERIOUS INJURY OR DEATH

- Wear Personal Protective Equipment to protect hands as cutter blades have extremely sharp edges and present a serious cutting hazard.

Do not connect any power to pump until this check is complete. Manually rotate the cutter to check that it spins freely with very little resistance. The cutter is located on the bottom of the pump. The cutter can be carefully rotated by hand, or rotated by inserting a tool into the cutter bolt. If rotating by hand, wear protective gloves as the cutter and cutter plate have sharp edges.

The pump can remain upright or can be laid down on its side for easier access to the cutter.

Besides verification that the cutter and impeller are freely spinning, rotating the cutter helps to lubricate the shaft seals if the pump has been non-operational for more than a week. It is recommended to rotate the cutter 5–10 full rotations.

Installation

⚠️ WARNING ⚡ RISK OF ELECTRIC SHOCK

- All installation and maintenance of pumps, controls, protection devices, and general wiring shall be done by qualified personnel.
- All electrical and safety practices shall be in accordance with the National Electrical Code®, the Occupational Safety and Health Administration, or applicable local codes and ordinances.

NOTICE

- ◆ For pressure sewer applications, verify a Redundant Check Valve Assembly (curb stop and check valve) is installed between the pump discharge and the street main, as close to the public right-of-way as possible, on all installations to protect from system pressures.

Electrical Connections

With mains power disconnected, complete pump and control wiring connections per manufacturer’s wiring diagrams included with the control panel and Figure 1 (external capacitor models)/ Figure 2 (3-phase models) as applicable. Check all wires for unintentional grounds after the connections are made.

Automatic Pump Direct Wiring

⚠️ WARNING ⚡ RISK OF SERIOUS INJURY OR DEATH

- In 208/230V installations, one side of the line going to the pump is always “hot”, whether the float switch is on or off. To avoid hazards, install a double pole disconnect near the pump installation.

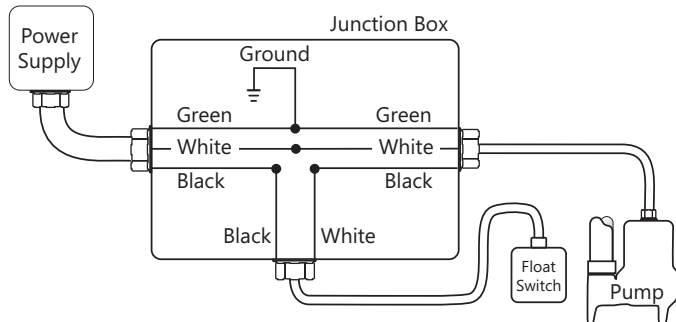

Figure 3. Direct Wiring of 208/230V, 1-Phase, Automatic Pumps

The pump can run on a voltage rating of 208V or 230V. Verify that it is the same as the supply voltage. The pump is supplied with a 6-20P (20A) cord plug end. If a 1-phase pump will be wired directly into a junction box, it is necessary to remove the plug. Qualified personnel shall complete the wiring in accordance with the National Electric Code and applicable local codes. A disconnecting means for the pump shall be located in sight from the pump/basin location. See Figure 3 for direct wire installation of 1-phase, automatic pumps.

3-Phase Pump Rotation Verification

NOTICE

- ◆ Check 3-phase pumps for correct rotation prior to installing pump(s) in basin. To change rotation, reverse any two of the three power leads to the pump (not the ground). Code the wires for reconnection after installation.

Three-phase power uses three separate alternating currents that peak at different integrals. With pumps that are powered by three phase electric, the phase sequence of the motor must match the phase sequence of the power source. When the phase sequences match, the pump operates properly. However, when the phases are out of order, the pump runs backward (i.e., the impeller rotates in the wrong direction). This causes an extreme loss of performance and could raise the current draw, which could result in tripping an overload or circuit breaker.

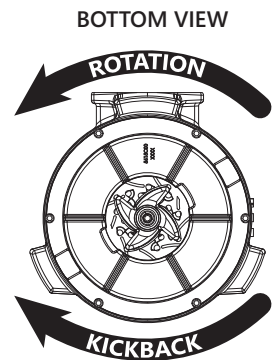

To ensure that the power to the pump is installed correctly, always verify proper rotation **before** lowering it into the basin. If the pump is rotating in the wrong direction, turn off the power and reverse any two power leads. This reverses the phase sequence and corrects the pump rotation. **Rotation must be counterclockwise when looking from the bottom of the pump.**

Piggyback Switch Operation

IMPORTANT: Verify breaker is turned off before plugging in the switch.

Plug the piggyback switch into a 6-20R receptacle. The receptacle must be wired to a 30 Amp breaker. Plug the pump into the piggyback receptacle. Install cable clamp for strain relief.

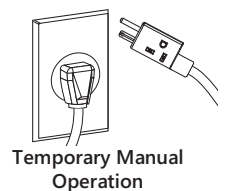
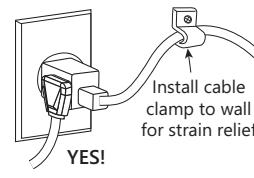
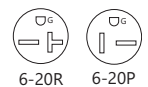

Discharge

Make all discharge connections. A check valve is required to prevent the backflow of liquid after each pumping cycle. A gate valve should follow the check valve to allow periodic cleaning of the check valve or removal of the pump. The remainder of the discharge line should be as short as possible with a minimum number of turns to minimize friction head loss. Do not reduce the discharge to below the pump outlet size. Larger pipe sizes may be required to eliminate friction head loss over long runs. Contact Liberty Pumps or other qualified person if questions arise regarding proper pipe size and flow rates.

Pressure Sewer Applications

A redundant check valve assembly consisting of a curb stop and check valve must be installed between the pump discharge and the street main, as close to the public right-of-way as possible, on all pressure (force main) sewer installations to protect from system pressures. The curb stop valve is necessary to isolate the site from the pressure sewer while the check valve provides redundant protection against potentially detrimental backflow. All valves and fittings should be rated for at least 200 PSI service. See Liberty Pumps line of CSV-Series Curb Stop/Swing Check Valve Assemblies and CK-Series Connection Kit.

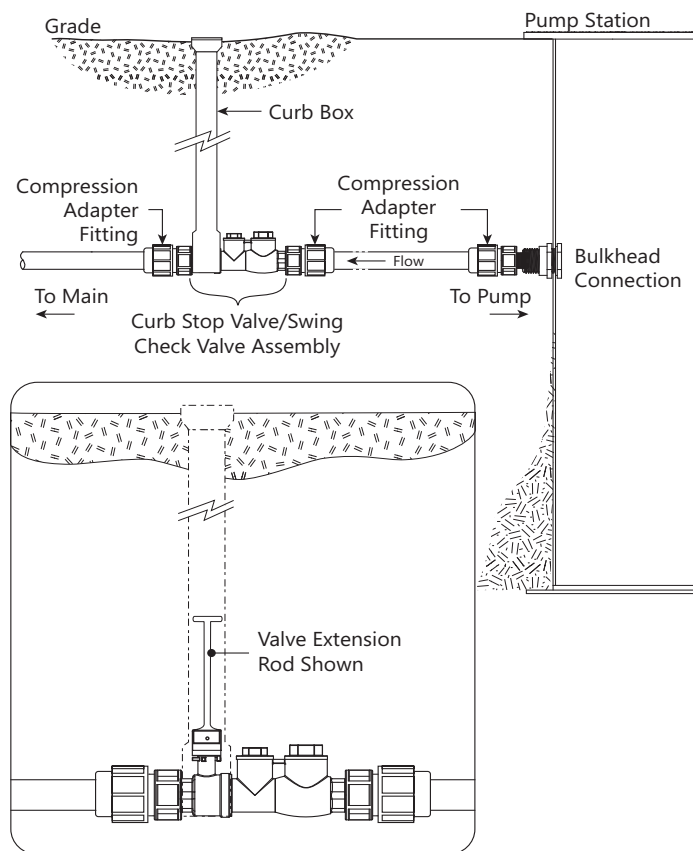

Guide Rail System

If guide rails are used, refer to the separate instructions supplied with the unit for proper installation and operation, making sure all gaskets and components are present. Liberty Pumps GR20 Guide Rail System features a self-aligning mounting bracket. Contact Liberty Pumps for more information.

If guide rails are not used, complete all pump-mounted plumbing at this time, being sure all gaskets and components are present.

Pump

Record information from pump nameplate onto the cover of these instructions. Complete a visual inspection before lowering into basin.

Place pump in basin being sure the mounting interface (i.e., guide rail, torque stop) is engaged correctly.

Vent

Vent basin in accordance with applicable plumbing codes.

Operation

⚠ WARNING **RISK OF SERIOUS INJURY OR DEATH**

- Energizing the control panel or breaker for the first time is potentially dangerous. Licensed electrical personnel should be present when the panel or breaker is energized for the first time. If faults caused by damage or poor installation practices have not been detected, serious damage, injury or death can result when power is applied.

Starting System

1. Verify all plumbing components in the basin are installed correctly and functional. Verify all valves are open and ready for pump use.
2. Double check all wire connections. Re-tighten all factory and field connections.
3. Ensure pump has no obstructions.
4. With all electrical and mechanical connections complete and secure, turn on power to pump and control panel, if applicable.
5. Verify operation of the pump, floats, and alarm circuits.
6. Run several cycles of water through the system to verify correct control operation for the installation.

Be certain to complete adequate testing, especially on systems with multiple pumps or custom control configurations.

Maintenance and Troubleshooting

⚠️ WARNING RISK OF ELECTRIC SHOCK

- Accidental contact with electrically live parts, items, fluid, or water can cause serious injury or death.
- Always disconnect pump(s) from power source(s) before handling or making any adjustments to either the pump(s), the pump system, or the control panel.

⚠️ WARNING RISK OF SERIOUS INJURY OR DEATH

- Wear adequate Personal Protective Equipment when working on pumps or piping that have been exposed to wastewater. Sump and sewage pumps often handle materials that can transmit illness or disease upon contact with skin and other tissues.
- Do not enter a pump basin after it has been used. Sewage and effluent can emit several gases that are poisonous.

NOTICE

- ◆ Verify correct 3-phase pump rotation before retuning to service.

Maintenance

As the motor is oil-filled, no lubrication or other maintenance is required. If replacement lubrication is required, use ISO VG 10 turbine oil. Use approximately 0.8 gallons to just cover the upper bearing of the motor.

To keep the pump/pump system operating smoothly, perform the following routine checks. Severe operating environments will require more frequent checks. For any issues that are not resolvable, contact Liberty Pumps for further assistance.

Monthly

1. Pumps that are idle for more than a month in a dry basin should have impellers manually operated through the breaker panel monthly to lubricate the seals.
2. Pumps that are idle in a wet basin must be removed.

Quarterly

1. Check pump for corrosion and wear.
2. Check for free and unobstructed float switch operation and float switch condition.
3. Inspect for proper check valve operation.
4. For multiple pumps, check for balanced operating times. Uneven times indicate a defective unit, float switch or control.
5. Inspect the control panel for any presence of moisture in enclosure, loose connections, and general component condition.

Annually

1. Inspect and clean basin. Replace any defective components.

Troubleshooting

Refer to Table 3 for help troubleshooting issues.

No repair work shall be carried out during the warranty period without prior factory approval. To do so may void the warranty.

Liberty Pumps, Inc. assumes no responsibility for damage or injury due to disassembly in the field. Disassembly, other than at Liberty Pumps or its authorized service centers, automatically voids warranty.

Table 3. Troubleshooting Matrix

Problem	Possible Cause	Corrective Action
Pump does not start.	Damaged power or control cord.	Replace as needed.
	Control panel selector switch in OFF position.	Set selector switch to Hand or Auto position.
	Blown control circuit transformer fuse.	Replace fuse.
	Tripped circuit breaker, tripped GFCI, blown fuse, or other interruption of power.	Reset tripped circuit breaker, reset GFCI, replace blown fuse with properly sized fuse, check that the unit is securely plugged in, investigate power interruption.
	Improper voltage.	Have an electrician check all wiring for proper connections and adequate voltage and capacity.
	Float switch unable to move to the pump ON position due to interference in basin or other obstruction.	Position the pump or float switch so that switch has adequate clearance for free movement.
	Insufficient liquid level.	Verify the liquid level is allowed to rise enough to activate float switch(es).
	Defective float switch.	Replace float switch.
	Obstructed impeller or volute.	Remove obstruction.

Table 3. Troubleshooting Matrix (continued)

Problem	Possible Cause	Corrective Action
Pump does not start.	Loose wiring connections.	Check and tighten all connections.
	Thermal overload tripped.	Wait for pump to cool to operating temperature.
	Water inside motor.	Check/replace oil, oil plug, and sealing washer as needed.
		Damaged lower lip seal or mechanical seal. Replace seal. Replace oil as needed.
		Damaged O-ring between oil chamber and motor plate. Return to authorized repair facility for O-ring and oil replacement.
Damaged cord. Replace as needed.		
Pump does not start and overload heaters trip.	Unintentional ground.	Turn off power and check motor leads for possible ground.
	3-phase motor winding failure.	Check resistance of motor windings. All three phases should have the same reading.
	Obstructed impeller or volute.	Remove obstruction.
Motor stops and then restarts after short period but overload heaters in starter do not trip.	Pump operating on a short cycle due to basin being too small.	A larger basin may be required. Consult Liberty Pumps.
Pump runs but does not turn off.	Pump is airlocked.	Turn pump off and let set for several minutes, then restart.
	Control panel selector switch in Hand position.	Set selector switch to Auto position.
	Float switch unable to move to the pump OFF position due to interference with the side of basin or other obstruction.	Position the pump or float switch so that it has adequate clearance for free movement.
	Control panel failure.	Check control panel.
	Defective float switch.	Replace float switch.
	Missing or faulty curb stop/swing check valve allowing system pressure to feed back through discharge piping.	Verify presence of a curb stop check valve or replace curb stop/swing check valve assembly.
Pump does not deliver proper capacity.	Discharge valve(s) partially closed or clogged.	Check the discharge line for foreign material, including ice if the discharge line passes through or into cold areas.
	Check valve partially clogged.	Raise liquid level up and down to clear; remove check valve to remove obstruction.
	Incorrect motor rotation.	1-phase internal capacitor models: contact factory. 1-phase exterior capacitor models: verify capacitor wiring in Figure 1, else consult factory. 3-phase: Correct 3-phase pump rotation direction. Refer to section 3-Phase Pump Rotation Verification .
	Total head is beyond pump's capability.	Route discharge piping to a lower level. If not possible, a larger pump may be required. Consult Liberty Pumps.
	Low liquid level.	Check liquid level.
	Obstruction in pump or piping.	Remove obstruction.

Table 3. Troubleshooting Matrix (continued)

Problem	Possible Cause	Corrective Action
High level alarm triggering.	Missing or faulty curb stop/swing check valve allowing system pressure to feed back through discharge piping.	Verify presence of a curb stop check valve or replace curb stop/swing check valve assembly.
Pump cycles too frequently.	Improper float switch setting.	Adjust float switch setting.
	Check valve not installed, stuck open, or leaking.	Install check valve(s); remove check valve and examine for freedom of operation and proper installation.
	Missing or faulty curb stop/swing check valve allowing system pressure to feed back through discharge piping.	Verify presence of a curb stop check valve or replace curb stop/swing check valve assembly.
Pump runs or hums, but does not pump.	Discharge line is blocked or restricted.	Check the discharge line for foreign material, including ice if the discharge line passes through or into cold areas.
	Check valve is stuck closed or installed backward.	Remove check valve(s) and examine for freedom of operation and proper installation.
	Gate or ball valve is closed.	Open gate or ball valve.
	Total head is beyond pump's capability.	Route piping to a lower level. If not possible, a larger pump may be required. Consult Liberty Pumps.
	Obstructed impeller or volute.	Remove obstruction.
	Pump is airlocked.	Turn pump off and let set for several minutes, then restart.
		Add baffle to reduce trapped air bubbles.
	Capacitor failure in control panel.	Check capacitors and replace if needed.
	Stuck/defective motor contactor in control panel.	Replace motor contactor.
Pump is not seated correctly in guide rail base.	Lift pump and re-position.	
Repeated tripping.	Circuit protection underrated.	Check rating and replace with proper size.
	Current unbalance.	Check current draw.
	Other appliance on same circuit.	Pump requires separate circuit.
	Pump is connected to an extension cord or wiring is inadequate or compromised.	Have an electrician check for proper wiring.
	Improper voltage.	Have an electrician check all wiring for proper connections and adequate voltage and capacity.
	Obstruction in pump.	Remove obstruction.
	Incorrect motor rotation.	1-phase internal capacitor models: contact factory. 1-phase exterior capacitor models: verify capacitor wiring in Figure 1, else consult factory. 3-phase: Correct 3-phase pump rotation direction. Refer to section 3-Phase Pump Rotation Verification .
		Foreign matter buildup.
Rupture or failure of discharge plumbing either inside or outside of the basin.	Missing or faulty curb stop/swing check valve allowing system pressure to feed back through discharge piping.	Verify presence of a curb stop check valve or replace curb stop/swing check valve assembly.

Table 3. Troubleshooting Matrix (continued)

Problem	Possible Cause	Corrective Action
Pump operates with control panel selector switch in Hand position but does not operate in Auto position.	Control circuits malfunctioning.	Check float level control or the alternator relay for issues.
		Check control panel.
Pump operates noisily.	Piping attachments to building are too rigid.	Replace a portion of the discharge line with rubber hose or connector.
	Incorrect motor rotation.	1-phase internal capacitor models: contact factory. 1-phase exterior capacitor models: verify capacitor wiring in Figure 1, else consult factory. 3-phase: Correct 3-phase pump rotation direction. Refer to section 3-Phase Pump Rotation Verification .
	Pump is being run below minimum head requirement causing cavitation.	A different sized pump or impeller may be required. Consult Liberty Pumps.
	Foreign objects in the impeller cavity.	Clean the impeller cavity.
	Broken impeller.	Consult Liberty Pumps for information regarding impeller replacement.
Pump runs periodically when fixtures are not in use.	Check valve not installed, stuck open, or leaking.	Install check valve(s); remove check valve and examine for freedom of operation and proper installation.
	Fixtures are leaking.	Repair fixtures as required to eliminate leakage.

Warranty

Liberty Pumps Wholesale Products Limited Warranty

Liberty Pumps, Inc. warrants that Liberty Pumps wholesale products are free from all factory defects in material and workmanship for a period of three (3) years from the date of purchase (excluding* batteries and "Commercial Series" models). The date of purchase shall be determined by a dated sales receipt noting the model and serial number of the pump. The dated sales receipt must accompany the returned pump if the date of return is more than three years from the date of manufacture noted on the pump nameplate.

The manufacturer's sole obligation under this Warranty shall be limited to the repair or replacement of any parts found by the manufacturer to be defective, provided the part or assembly is returned freight prepaid to the manufacturer or its authorized service center, and provided that none of the following warranty-voiding characteristics are evident:

The manufacturer shall not be liable under this Warranty if the product has not been properly installed, operated, or maintained per manufacturer instructions; if it has been disassembled, modified, abused, or tampered with; if the electrical cord has been cut, damaged, or spliced; if the pump discharge has been reduced in size; if the pump has been used in water temperatures above the advertised rating; if the pump has been used in water containing sand, lime, cement, gravel, or other abrasives; if the product has been used to pump chemicals, grease, or hydrocarbons; if a non-submersible motor has been subjected to moisture; or if the label bearing the model and serial number has been removed.

Liberty Pumps, Inc. shall not be liable for any loss, damage, or expenses resulting from installation or use of its products, or for indirect, incidental, and consequential damages, including costs of removal, reinstallation or transportation.

There is no other express warranty. All implied warranties, including those of merchantability and fitness for a particular purpose, are limited to three years from the date of purchase. This Warranty contains the exclusive remedy of the purchaser, and, where permitted, liability for consequential or incidental damages under any and all warranties are excluded.

*Liberty Pumps, Inc. warrants StormCell® batteries for 1 year from date of purchase, and warrants that pumps of its Commercial Series are free from all factory defects in material and workmanship for a period of 18 months from the date of installation or 24 months from the date of manufacture, whichever occurs first, and provided that such products are used in compliance with their intended applications as set forth in the technical specifications and manuals.