

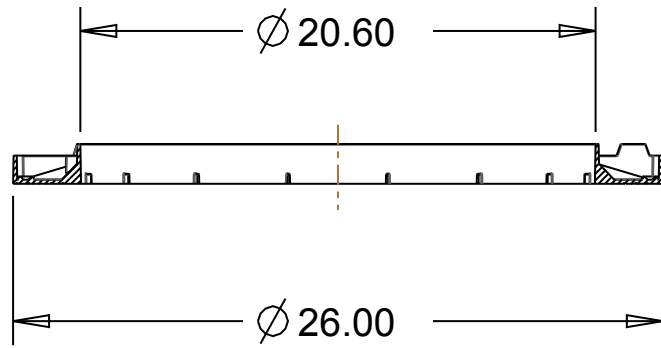

**DRAINAGE
SOLUTIONS, INC**

(317) 346-4110

www.drainagesolutionsinc.com



SECTION A-A

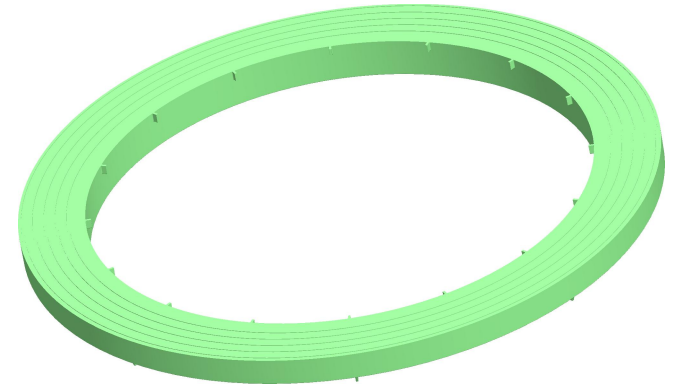
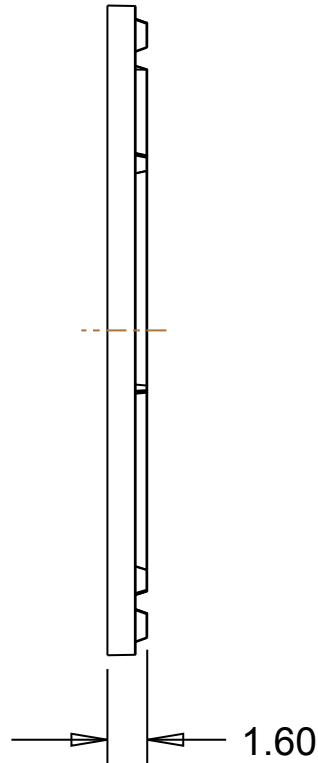
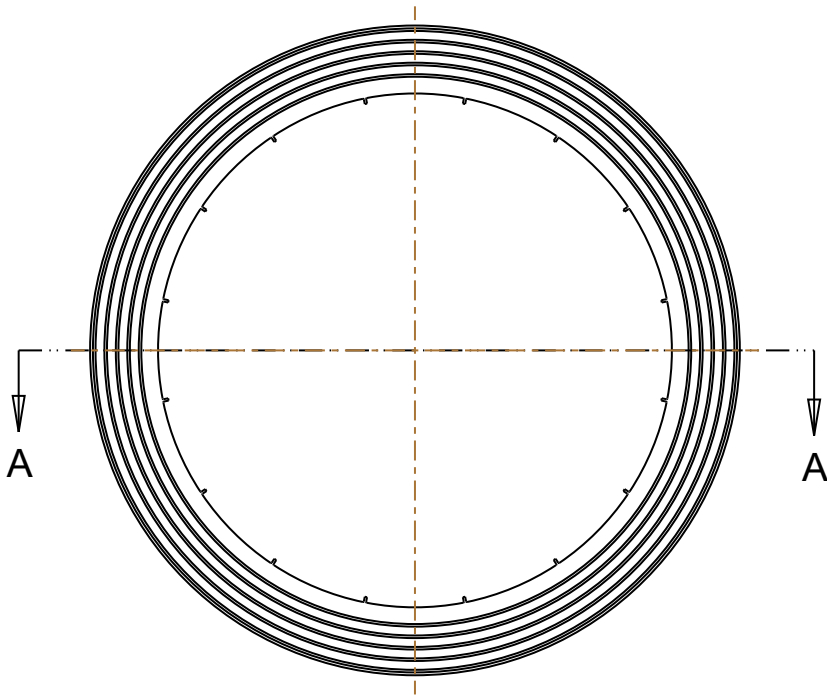
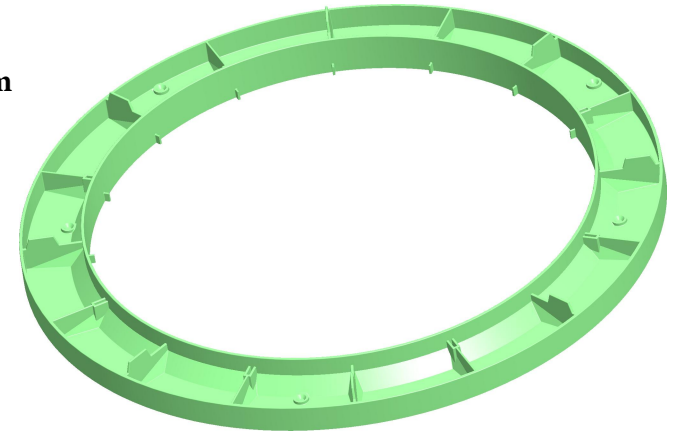

**Material: Copolymer Polypropylene
Color: Green**



Drainage and Septic Products

(317) 346-4110

www.drainagesolutionsinc.com

PART NAME: 20" TAR

PART #: 20 - TAR - GREEN