



**DRAINAGE
SOLUTIONS, INC**

(317) 346-4110

www.drainagesolutionsinc.com

SECTION A-A

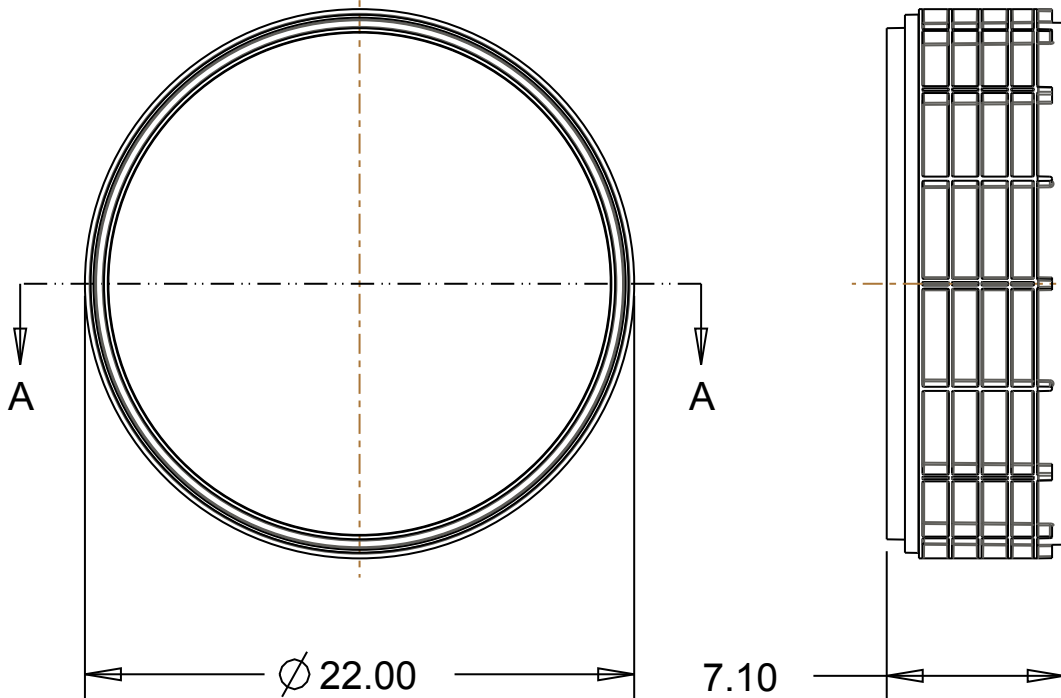
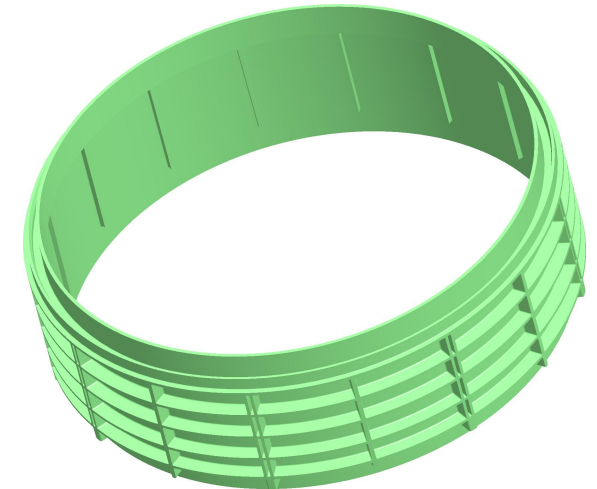
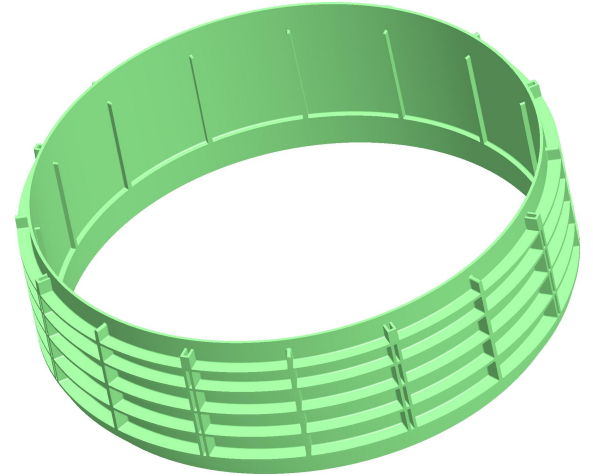
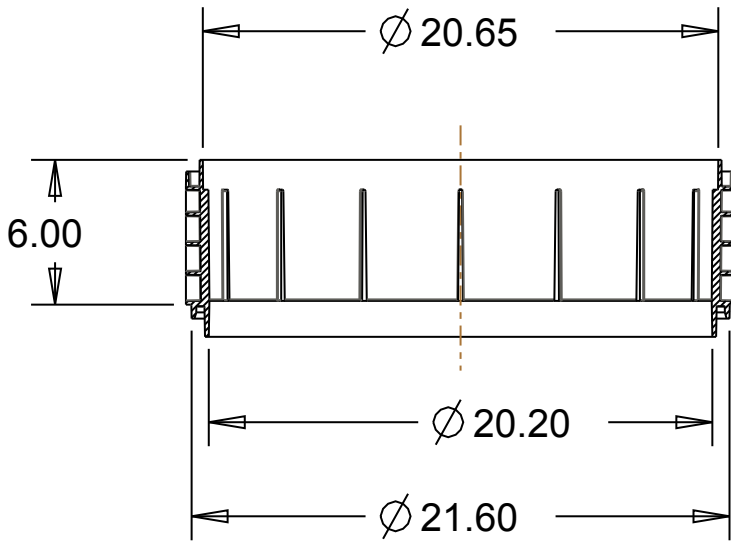

**Material: Copolymer Polypropylene
Color: Green**



Drainage and Septic Products

(317) 346-4110

www.drainagesolutionsinc.com

PART NAME:

20" RISER

PART #:

20 - RIS - GREEN