

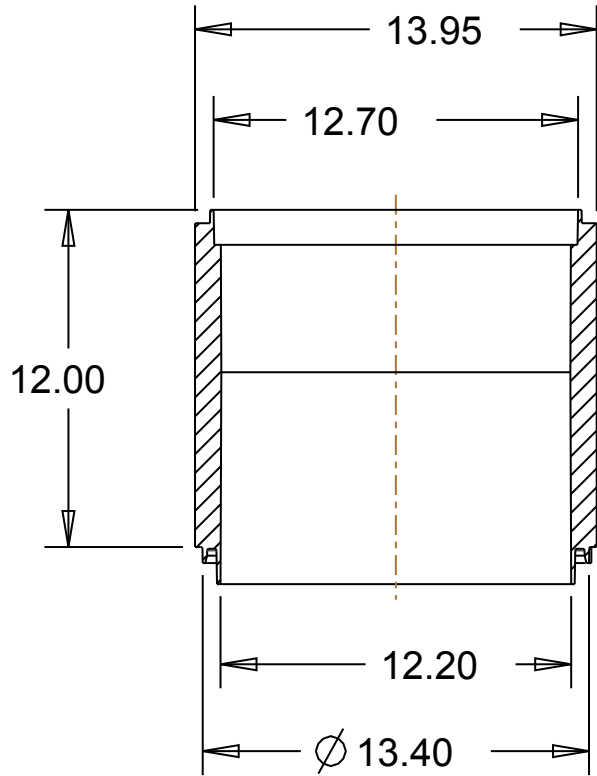

**DRAINAGE
SOLUTIONS, INC**

(317) 346-4110

www.drainagesolutionsinc.com



SECTION A-A

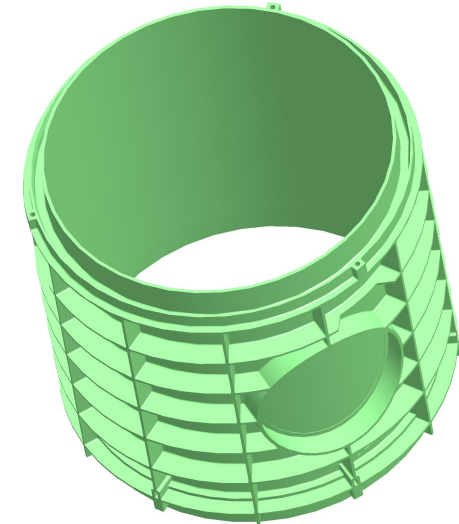
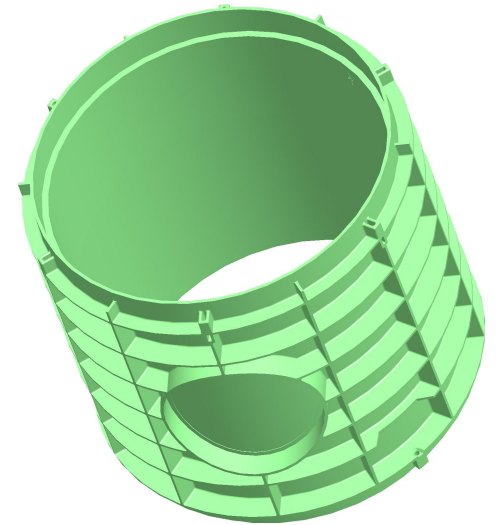
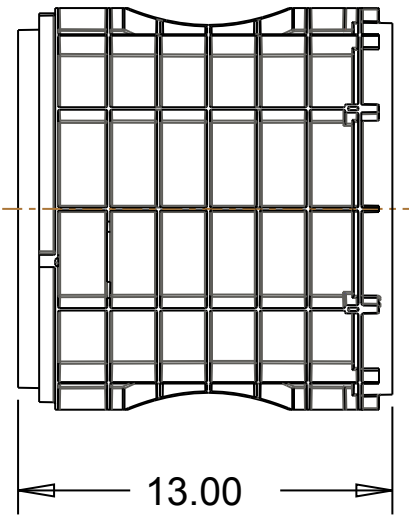
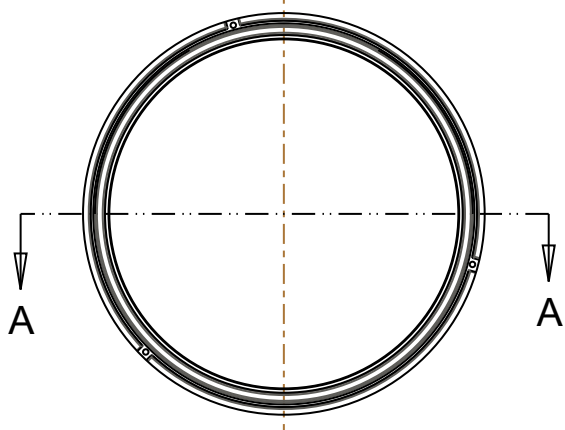

**Material: Copolymer Polypropylene
Color: Green**



Drainage and Septic Products

(317) 346-4110

www.drainagesolutionsinc.com

PART NAME: 12 X 12 RISER

PART #: 12 X 12 - RIS - GREEN