



(317)346-4110

**DRAINAGE SOLUTIONS, INC** www.drainagesolutionsinc.com

# Model S3-7

Order Verification Form

CUSTOMER.

VERIFICATION MUST BE RECEIVED BEFORE ORDER CAN BE ENTERED FOR SHIPMENT.

PLEASE SIGN TO VERIFY S3-7FT. BURY MEETS YOUR REQUIREMENTS.

\_\_\_\_\_  
Customer Signature

\_\_\_\_\_  
Please print name and return to Woodford Mfg. FAX: 800-765-4115

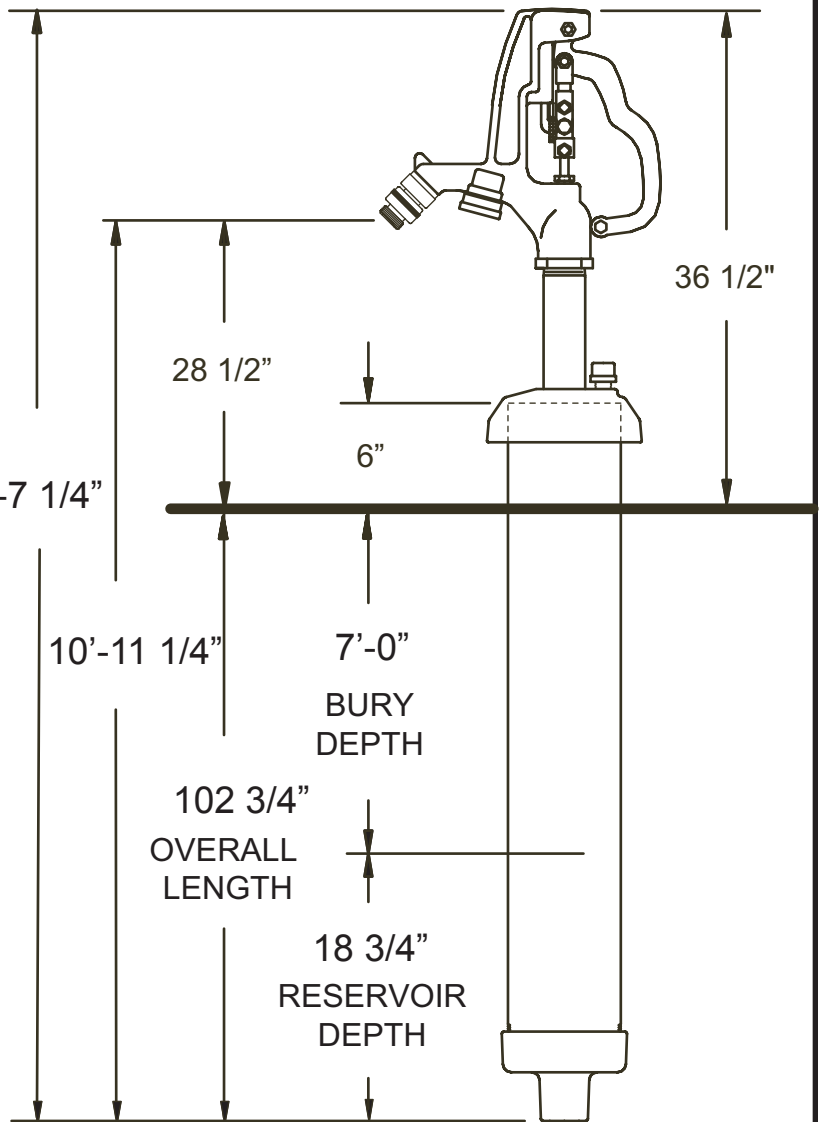

## WOODFORD MANUFACTURING COMPANY, LLC.

2121 Waynoka Road, Colorado Springs, Colorado 80915 • Phone: (800) 621-6032 • Fax: (800) 765-4115  
To view our complete product line visit: [www.woodfordmfg.com](http://www.woodfordmfg.com) or email: [sales@woodfordmfg.com](mailto:sales@woodfordmfg.com)