

SECTION A-A

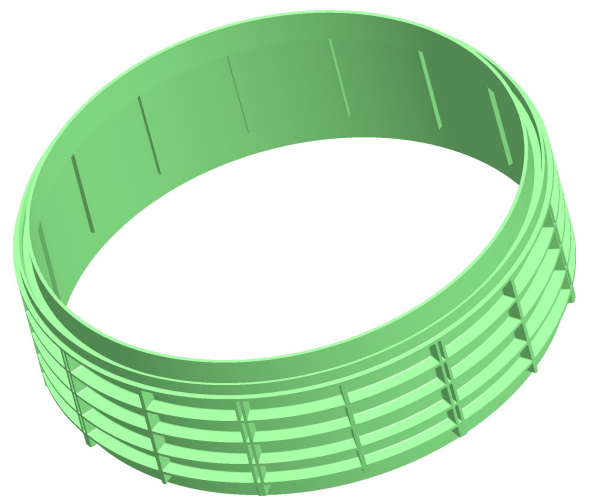

Material: Copolymer Polypropylene
Color: Green

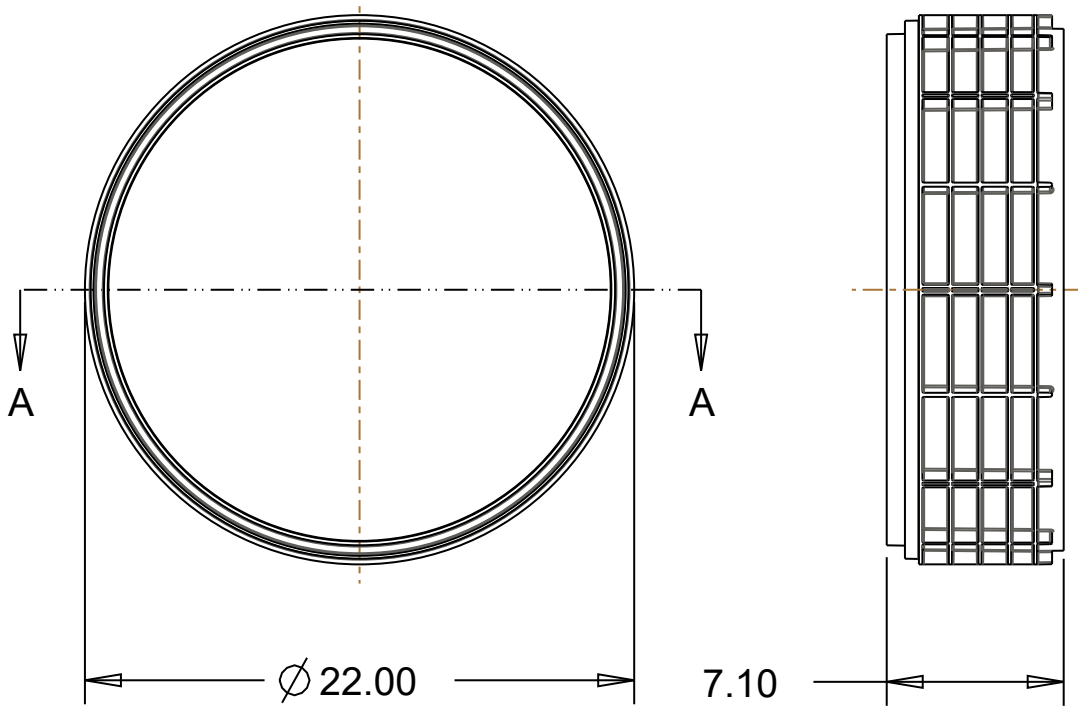
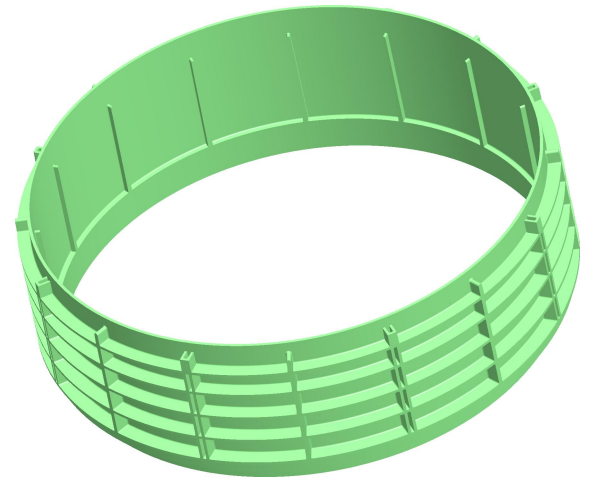

Drainage and Septic Products



DRAINAGE SOLUTIONS, INC.

(317) 346-4110
www.drainagesolutionsinc.com

PART NAME: 20" RISER
PART #: 20 - RIS - GREEN